



# OUTDOOR 13' SEE THROUGH FIREPLACE SYSTEM



Natural Gas





Serial #: 7280

[www.acucraft.com](http://www.acucraft.com)

888-317-6499

 <b>DANGER</b>	<b>CARBON MONOXIDE HAZARD</b> This appliance can produce carbon monoxide which has no odor. Using it in an enclosed space can kill you. Never use this appliance in an enclosed space as a camper, tent, car or home.
	

 <b>WARNING</b>
Improper installation, adjustment, alteration, service, or maintenance can cause injury or property damage. Read the installation, operating and maintenance instructions thoroughly before installing or servicing this equipment.

 <b>DANGER</b>
If you smell gas: 1. Shut off gas to appliance. 2. Extinguish any open flame. 3. If odor continues, keep away from the appliance and immediately call your gas supplier or fire department.

 <b>WARNING</b>
Do not store or use gasoline or other flammable vapors and liquids in the vicinity of this or any other appliance. An LP-cylinder not connected for use shall not be stored in the vicinity of this or any other appliance.

 <b>WARNING: For Outdoor Use Only</b>
--

<b>INSTALLER: Leave this manual with the appliance. CONSUMER: Retain this manual for future reference.</b>
--

Complies with ANSI Z21.97-2014 / CSA 2.41-2014

# Installation/Operator's Manual

# TABLE OF CONTENTS

---

<b>Introduction .....</b>	<b>pg 3</b>
<b>Safety / Guide .....</b>	<b>pg 4</b>
<b>Installation Guide</b>	
System Illustration .....	pg 8
Wiring Diagrams .....	pg 9
Connecting the Gas Valve & Ignition System .....	pg 10
Installing the Log Set .....	pg 14
<b>Operation Guide</b>	
Instructions .....	pg 19
Lighting Instructions.....	pg 20
Troubleshooting .....	pg 21
Caution .....	pg 23
Maintenance & Care .....	pg 24
Specifications .....	pg 25
Notes .....	pg 29
<b>Warranty .....</b>	<b>pg 30</b>

# ***INTRODUCTION***

---



Acucraft Fireplaces  
19672 172nd Street  
Big Lake, MN 55309

*www.acucraft.com*      888-317-6499

# SAFETY



## WARNING

This appliance should be inspected before use and at least annually by a qualified service person. More frequent cleaning may be required as necessary. It is imperative that the control compartment, burners and circulating air passageways of the appliance be kept clean.



## DANGER

Carbon monoxide poisoning may lead to death!

**Carbon Monoxide Poisoning:** Early signs of carbon monoxide poisoning resemble the flu, with headaches, dizziness, or nausea. If you have these signs, the system may not be working properly.

**Get fresh air at once!** Have the system serviced. Some people are more affected by carbon monoxide than others. These include pregnant women, people with heart or lung disease or anemia, those under the influence of alcohol, and those at high altitudes.

**Natural Gas:** Natural gas is odorless. An odor making agent is added to the gas. The odor helps you detect a gas leak. However, the odor added to the gas can fade. Gas may be present even though no odor exists.

Make certain you read and understand all warnings. Keep this manual for reference. It is your guide to safe and proper operation of this appliance.

### HIGH ALTITUDE INSTALLATIONS:

The appliance is rated for installation up to 4500' (1372m) above sea level. Above 4500' the appliance must be de-rated at the factory for the appropriate altitude.

### LOCAL CODES

Install and use the system with care. Follow local codes. In the absence of local codes, use the latest edition of *The National Fuel Gas Code ANSI Z223.1/NFPA 54* available from:

- American National Standards Institute Inc., 1430 Broadway, New York, NY 10018
- National Fire Protection Association Inc., Batterymarch Park, Quincy, MA 02269.



## WARNING

Any change to this appliance or its controls can be dangerous.

1. This appliance, as supplied, is only for use with the type of gas indicated on the rating plate.
2. When an appliance is for connection to a fixed piping system, the installation must conform with local codes, or in the absence of local codes with the *National Fuel Gas Code, ANSI Z223.1/NFPA 54, or International Fuel Gas Code, Natural Gas Installation Code CSA B149.1.*
3. Keep the appliance area clear and free from combustible materials, gasoline and other flammable vapors and liquids.
4. Do not burn solid fuel in the fireplace after installing the appliance. Do not use this appliance to cook food or burn paper or other objects.
5. **Children and adults should be alerted to the hazards of high surface temperatures and should stay away to avoid burns or clothing ignition.**
6. **Clothing or other flammable materials should not be hung from the appliance, or placed on or near the appliance.**
7. **Young children should be carefully supervised when they are in the area of the appliance.**
8. The appliance, when installed, must be electrically grounded in accordance with local codes or, in the absence of local codes, with the *National Electrical Code, ANSI/NFPA 70*, if applicable.
9. **Do not use appliance if any part has been under water. Immediately call a qualified service technician to inspect the room appliance and to replace any part of the control system and any gas control which has been under water.**
10. Inspect the burner before each use of the system. The burner must be replaced prior to the appliance being put into operation if it is evident that the burner is damaged. For replacement please contact Acucraft at: 763-263-3156 or [service@acucraft.com](mailto:service@acucraft.com).
11. Turn the appliance off and let cool before servicing, installing, or repairing. **Any guard or other protective device removed for servicing the appliance must be replaced prior to operating the appliance.** Only a qualified service person should install, service, or repair the appliance.

# INSTALLATION GUIDE

**Note:** The installation of this product must conform with local codes or, in the absence of local codes, the current **National Fuel Gas Code - ANZI Z223.1 (NFPA 54)** Installation Code. Please check local codes before installation.

## NOTE TO INSTALLER:

1. This appliance is for **OUTDOOR USE ONLY**. **DO NOT** install or use this appliance inside a building, garage or any other enclosed area, including recreational vehicles and/or boats. **This unit must be installed in such a manner that the combustion air intake at the base of the unit remains clear and free of all obstructions at all times and during all weather conditions.**
2. **FOR NATURAL GAS:** The minimum inlet pressure is 0.25 psi and the maximum inlet gas-supply pressure is 2.0 psi. The normal operating inlet pressure is 7" WC. **DO NOT INSTALL THIS UNIT IF MINIMUM PRESSURE IS NOT AVAILABLE OR IF MAXIMUM PRESSURE IS EXCEEDED.**
3. Gas piping system must be sized to provide minimum inlet pressure at the maximum flow rate (BTU/hr). 45,000 to 60,000 BTU's based on the desired flame height. Undue pressure loss will occur if the pipe is too small, or the run is too long.
4. The appliance and its appliance main gas valve must be disconnected from the gas supply piping system during any pressure testing of that system at test pressures in excess of 1/2 psi (3.5 k/Pa). The appliance must be isolated from the gas valve supply piping system by closing the equipment shutoff valve during any pressure testing of the gas supply piping system at test pressures equal to or less than 1/2 psi (3.5 k/Pa).



## WARNING

If the information in these instructions is not followed exactly, a fire or explosion may result causing property damage, personal injury or loss of life.

- Do not store or use gasoline or other flammable vapors and liquids in the vicinity of this or any other appliance.
- WHAT TO DO IF YOU SMELL GAS
  - Do not try to light any appliance
  - Do not touch any electrical switch; do not use any phone in your building
  - Immediately call gas supplier from a neighbor's phone. Follow the gas supplier's instructions.
  - If you cannot reach your gas supplier, call the fire department.
- Installation and service must be performed by a qualified installer, service agency or the gas supplier.

# INSTALLATION GUIDE

---

## INSTALLATION SAFETY GUIDELINES

1. Installation and repair should be done by a qualified service person. The appliance should be inspected before use and at least annually by a qualified service person. More frequent cleaning may be required as necessary. It is imperative that the control compartment, burners and circulating air passageways of the appliance be kept clean.
2. Carefully inspect for shipping damage. If any parts are damaged, call Acucraft at 763-263-3156.
3. Correct installation and proper placement of the unit and decorative media is crucial to safe performance of the unit. See installation instructions for further information.
4. A listed manual gas shutoff device must be installed prior to the location of the fireplace.

## TO INSTALL THE BURNER

The installation of this appliance must conform with local codes or, in the absence of local codes, with the *National Fuel Gas code, ANSI Z223.1/NFPA54*, or the *Natural Gas and Propane Installation Code, CSA B149.1*.

Final assembly of this fireplace on site consists of the following main steps:

1. Positioning and securing of the fire pit
2. Connecting the gas valve and ignition system
3. Installing fireplace media and fireplace glass panes, if applicable

## POSITIONING THE FIREPLACE

- The burner is designed to sit directly on non-combustible materials
- Identify the location of the fire pit
- Set the burner over the incoming gas line

**Note:** The appliance should be positioned in a manner that planned gas line access is available with adequate clearance for servicing from the top of the fire pit.

\*Clearances must be in accordance with local installation codes and requirements of the gas supplier.\*

# INSTALLATION GUIDE

## GAS INFORMATION

Fuel - Before making gas connections ensure appliance being installed is compatible with the available gas type.

Gas Pressure - Proper Input Pressures are required for optimum appliance performance. Gas line sizing requirements need to be made following NFPA51.

### Pressure Requirements for Appliance (Natural Gas)

**Minimum Inlet Pressure: 0.25 psi**

**Nominal Operating Inlet Pressure: 7" WC (NG)**

**Maximum Inlet Pressure: 2.0 psi**

Gas Connection - Have the gas supply line installed in accordance with local building codes, if any. If not, follow ANSI 223.1. Installation should be done by a qualified installer approved and/or licensed as required by locality.

**Note: A listed manual gas shutoff device must be installed prior to the location of the appliance.**

Startup - A small amount of air will be in the gas supply lines. When first lighting appliance it will take a short time for air to purge from the lines. Subsequent lighting of the appliance will not require such purging.



## WARNING

Check for Gas Leaks after installation complete

- Check all fittings and connections
- Do not use open flame to check for leaks
- Check for leaks with a commercially available, non-corrosive leak check solution

## Electrical Information

Note: The 24 volt transformer supplied is to be located in a remote location away from the fire feature in an approved weatherproof electrical junction box and installed in accordance with local codes.

## Recommended Wire Size

No less than 12 gauge wire for all installations

Note: There are numerous electrical devices that can be used to turn the fire feature on and off. Devices such as wall switches and remote control devices that are used should be UL listed and approved devices for turning high voltage (110 v electrical power) on and off. This high voltage electrical power shall be connected to the supplied 24 volt AC transformer by a qualified electrical installer.

# INSTALLATION GUIDE

This is a vented decorative gas appliance: not a source of heat; not for use with solid fuel.

## IMPORTANT NOTE TO INSTALLER:

1. This appliance is not intended or designed to be installed in a mobile or manufactured home.
2. If this appliance is installed on carpeting, tile, or any combustible material other than wood flooring, the appliance shall be installed on a metal, concrete, or wood panel extending the full width and depth of the fireplace.
3. The appliance and its main gas valve must be disconnected from the gas supply piping system during any pressure testing of that system at test pressures in excess of ½ psi. (3.5 k/Pa) The appliance must be isolated from the gas valve supply piping system by closing the equipment shutoff valve during any pressure testing of the gas supply piping system at test pressures equal to or less than ½ psi (3.5 k/Pa)

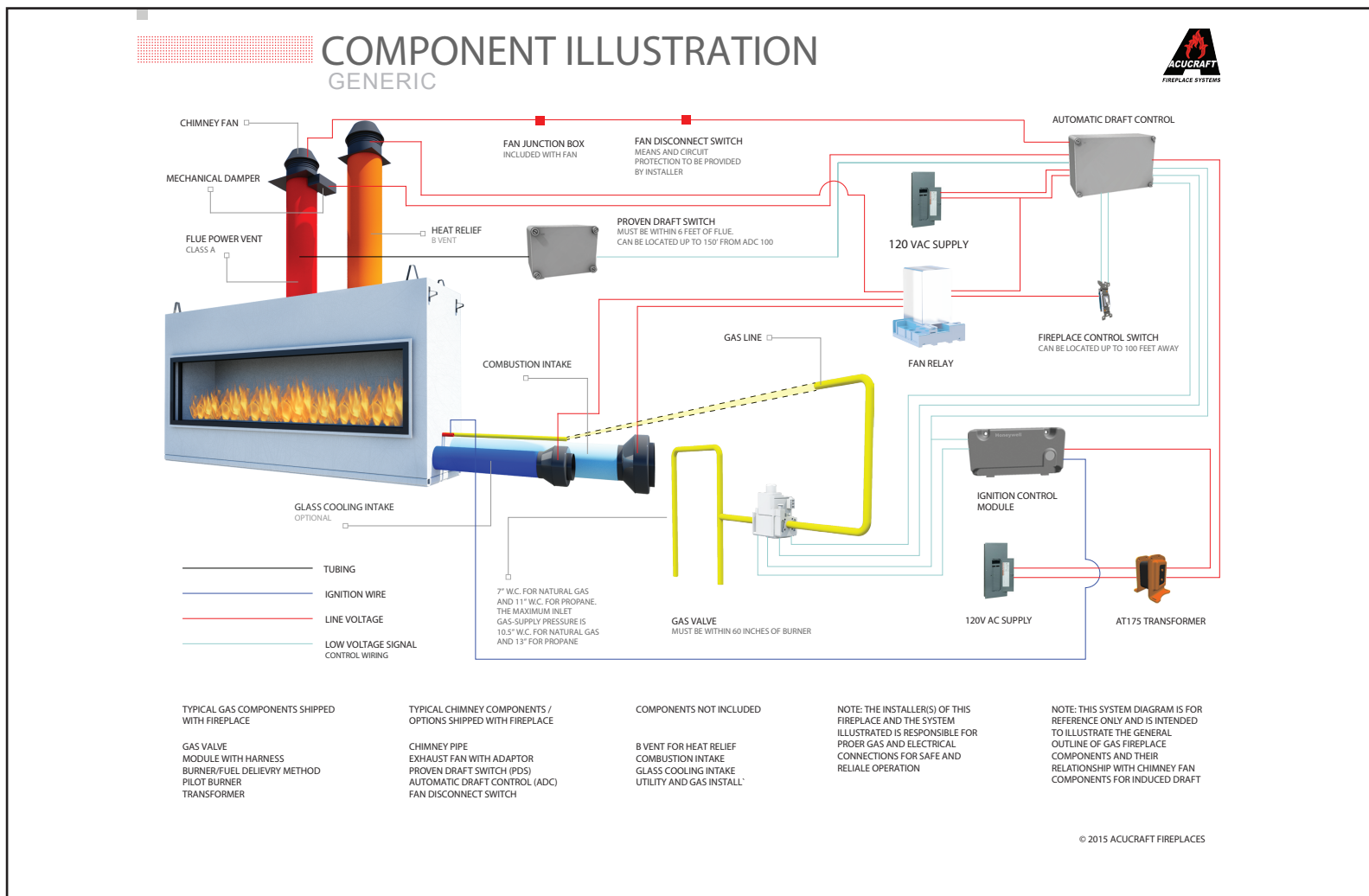



# INSTALLATION GUIDE

## Fireplace Wiring Diagram

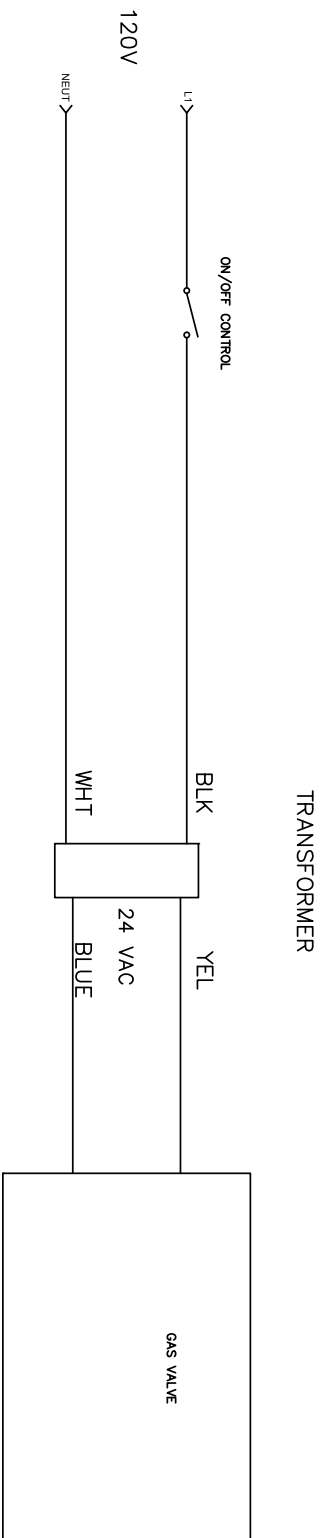

- NOTES:
1. TRANSFORMER MUST BE PLACED IN OUTDOOR RATED ENCLOSURE
  2. ON/OFF CONTROLS SHOULD BE LISTED AND APPROVED



Acucraft Fireplace Systems  
19672 172nd ST. NW  
Big Lake, MN 55309  
PH. 763-263-3156  
FAX 763-263-8311

NOTE: INSTALLATION MUST CONFORM WITH ALL LOCAL CODES AND ORDINANCES. PLEASE READ ALL LITERATURE BEFORE PLANNING YOUR INSTALLATION AND CONTACT OUR SUPPORT DEPARTMENT IF YOU SHOULD NEED CLARIFICATION. SAFETY TEST ENTIRE SYSTEM WHEN DONE!

# INSTALLATION GUIDE

## Installation – Natural Gas

**Note:** Installation should be done by a qualified service technician that is locally licensed.

1. In the photo at right there is a bowl with both a gas riser and an electrical conduit stubbed up inside the bowl. In this photo the gas riser is centered whereas the electrical is off center. It is preferred to stub the gas riser centered in order to ensure the fire ring is centered in the bowl once installation is complete.

**NOTE:** Drainage **MUST** be provided in the bottom of the bowl. Drainage can be obtained by making a simple hole as shown at right or providing a drain line next to the gas and electrical conduit.

2. Apply pipe dope to the gas stub and thread the AWEIS onto the gas riser as shown in the photo at right.

**NOTE:** Leak Test – it is highly recommended to perform a gas leak test at this point in the install. Turn on the gas supply and then, using a soapy water solution spray the bottom of the AWEIS where it is connected to the gas line to ensure no leaks exist.

3. Electrical Connections / Orifice Install. In the photo at right the wires protruding from the AWEIS have been connected to the two wires from the electrical conduit using appropriate sized wire nuts.

In addition a short pipe nipple and the Natural Gas Orifice (supplied) are installed using either Teflon tape or gas plumbing pipe dope.

4. On the side of the AWEIS there are two connections for the Pilot Burner Assembly as shown in the photo at right. The white 'quick connect' is the electrical connection and the brass plumbing fitting is the gas connection. There is a label next to these connections, "Attach Pilot Burner Here".

5. The photo at right shows the AWEIS after the Pilot Burner Assembly has been connected.

**NOTE:** The electrical connection for the Pilot Burner Assembly is a shaped connection thereby ensuring it can only be connected the correct way. On the Pilot Burner Assembly side of the connection there is a locking clip on the quick connect that will 'lock' the connection in place. Therefore after making the connection lightly tug on the connection to ensure it is in fact 'locked' in place.

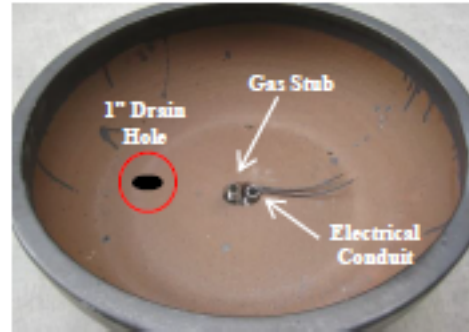

# INSTALLATION GUIDE

---

6. Install the Heat Deflector Shield. Notice the heat shield has a notch on one side. Position the Pilot Burner in the notch **ONLY** when using either a 6" or 18" fire ring. For all other burner sizes attach the Pilot Burner to the heat shield on the opposite side of the notch as shown in photo at right. Use the two screws that came with the heat shield to attach the Pilot Burner to the heat shield.



7. Install Fire Ring using either Teflon tape or gas plumbing pipe dope. Holes in the Fire Ring **MUST FACE UP**.



# INSTALLATION GUIDE

## Attachment 1 Automated Pool Controller Wiring

**Wiring When  
2 Fire Features  
Turned On & Off  
with One Button**

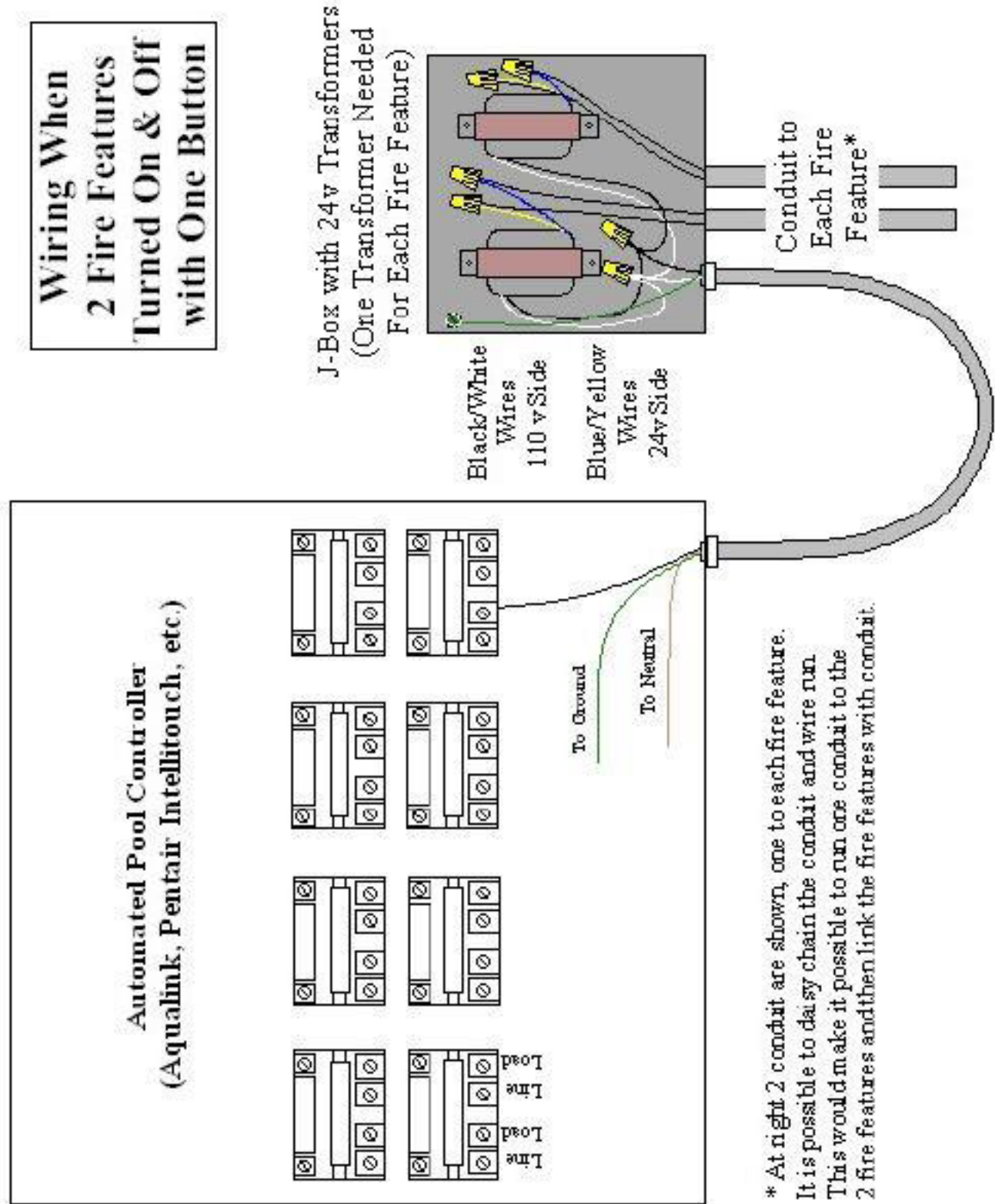

\* At night 2 conduit are shown, one to each fire feature. It is possible to daisy chain the conduit and wire run. This would make it possible to run one conduit to the 2 fire features and then link the fire features with conduit.



# INSTALLATION GUIDE

---



## Control Box

Connection of the ignition system to the burner. On the side of the AWEIS there are two connections for the pilot burner assembly. The white “quick connect” is the electrical connection and the brass plumbing fitting is the gas connection. There is a label next to these connections, “Attached Pilot Burner Here.”

Connection of the wiring harness/pilot tubing extension is shown to the bottom of the igniter.

## Pilot Assembly Mount



# INSTALLATION GUIDE

## Installing the Log Set



## WARNING

Always wear protective equipment when dealing with open flames. Failure to follow this warning may result in serious injury.

**Log placement is very important for the proper operation of the Real-Fyre® gas log set.** Although you have some flexibility in the log arrangement, it is necessary to follow the LOG PLACEMENT instructions carefully to fully enjoy your log set. Follow the steps below, referring to Fig. 7-1 through Fig. 7-5.

1. The second-longest log, the rear log, is placed on the rear of the grate with the bark of the log facing forward (Fig. 7-1). Center the log left to right (Fig. 7-5 #1). If the log has a head chamber (a recess in the back), it can face either forward or to the rear.
2. The longest log, the front log, is placed on the front of the grate with the bark facing forward. Center left to right (Fig. 7-2 #2). If the log has a heat chamber, it should face to the rear. **NOTE: Be sure to maintain a space between the front and rear logs** (Fig. 7-1). This creates energy efficiency, heat radiation, and reduces carbon buildup.
3. Top logs should be stacked diagonally, with the largest at the bottom (Fig. 7-3, #3 & 4), and with spaces between the logs so that the flames are not choked off. Place the smaller logs diagonally across the larger ones (see Fig. 7-4, #5 & 6). The top logs may be moved to achieve desired flame pattern. Some carbon buildup (sooting) may occur where the flames impinge on the logs and should not be a concern unless excessive. If sooting is excessive, rearrange the top logs to reduce flame impingement. Examples of log stacks are shown below.

**Note: Although log styles may differ in pattern or shape (Fig. 7-6), layout is essentially the same. Adequate spacing between the logs is NECESSARY and MUST be maintained for best performance.**

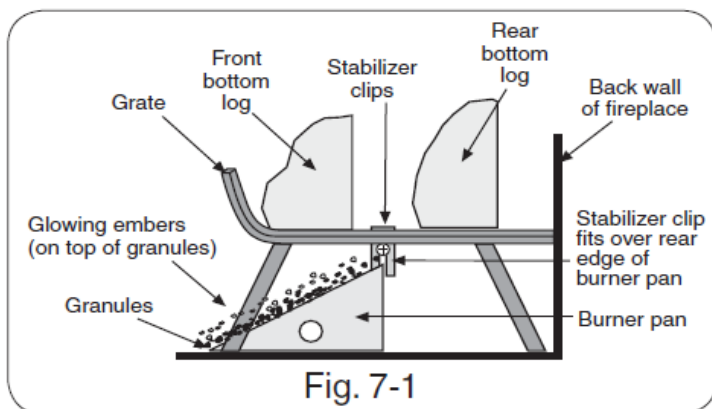

# INSTALLATION GUIDE

## Installing the Log Set

**STEP 1.** Place the second-longest log to the rear.

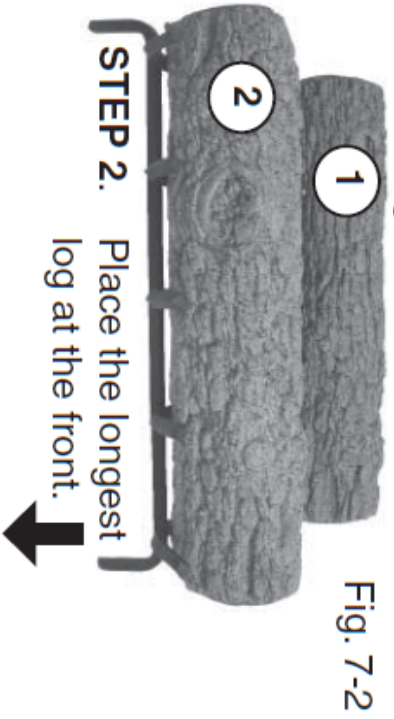

**STEP 2.** Place the longest log at the front.

**STEP 3.** Place the largest top logs across the bottom logs.

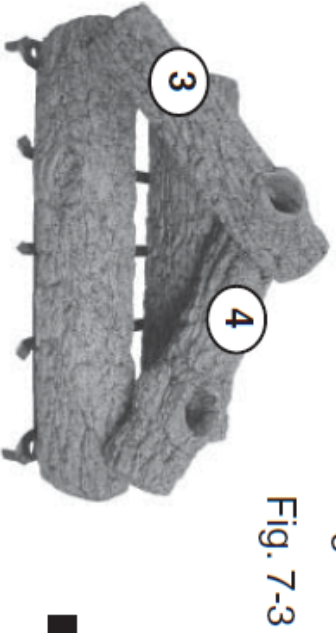

Knotholes go to the front or back as desired.

Alternative examples of log layout (Split Oak set shown). Note the space between the logs.



**STEP 3 (cont.)** Place the smaller top logs across the other logs.

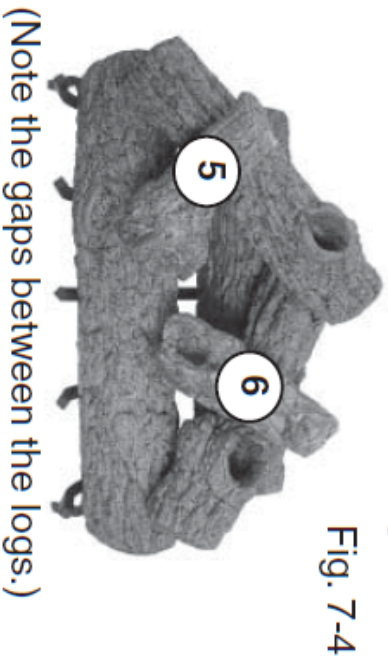

Note: 24" Golden Oak (R-24) shown

(Note the gaps between the logs.)

Royal English Oak Designer



Split Oak Designer Plus



Woodland Oak



Fig. 7-6 - Recommended log patterns

# INSTALLATION GUIDE

## Installing the Log Set

**Note:** Optional Charred Series log sets are supplied with an ember screen (Fig. 8-1).

Attach the ember screen to the burner by slipping it onto the back edge (center left to right) with the perforated section facing toward the back fireplace wall (Fig. 8-1). Cover the surface of the ember screen with the Glowing Embers (Fig. 8-2). For best glowing performance, they should be applied evenly and pulled slightly apart so the fibers are somewhat loose. (It is not necessary to pile the entire bag of the Glowing Embers. More Glowing Embers may be added after completion of the entire installation).

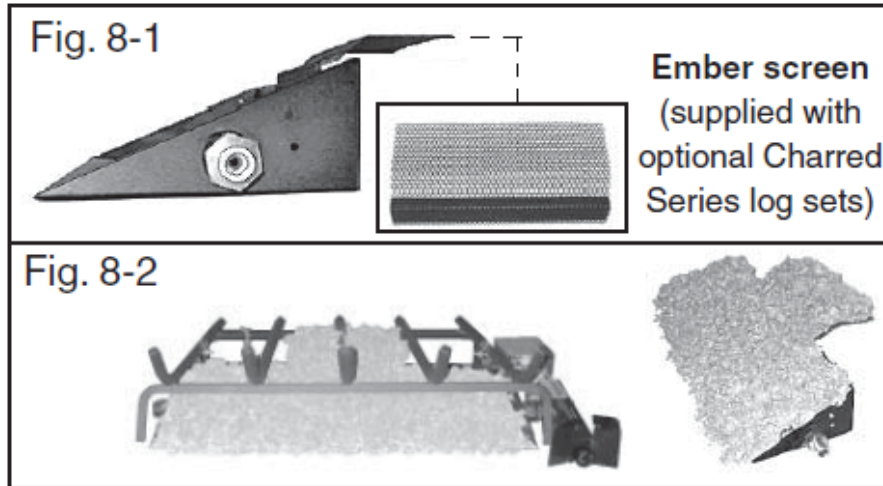

### LOG PLACEMENT

Log styles and sizes will vary depending upon the Charred Series log set ordered.  
**CHARRED SPLIT (CHS) layout shown.**

Place the long bottom rear log (Log #2) on the back of the grate with the flat featureless side facing the rear of the fireplace. The two sections of the front log (Logs #1A & 1B) are placed on the front of the grate with the charred sections facing each other and approximately 1 inch apart at the top (Fig. 8-3). Slide the logs to the front of the grate.

**Note: Be sure to maintain a space between the front and rear logs (Fig. 8-3).** This creates energy efficiency and heat radiation, and reduces carbon buildup.

Place the two curved logs (Logs #3 & 4) so that one end rests on each front log section (Logs #1A & 1B) and the other end rests on the rear log (Log #2).

The charred sections should be over the opening between the front and rear logs (Fig. 8-4).

Place the small top charred logs (Logs #5 & 6) so they rest over the charred sections of the front bottom log sections (Logs #1A & 1B) and on the two curved logs (Logs #3 & 4) (Fig. 8-5).

Finally, place the curved top charred log (Log #7) to rest on the two top logs at rear, but not encroaching into the space between rear and front logs (Fig. 8-6).

**Note:** The additional log (Log #7) is not available with 18" log sets.



# INSTALLATION GUIDE

## Installing the Log Set



Fig. 8-3



Fig. 8-4

Fig. 8-5



MAINTAIN A SPACE IN THE CENTER OF  
THE LOGS AT ALL TIMES

Fig. 8-6

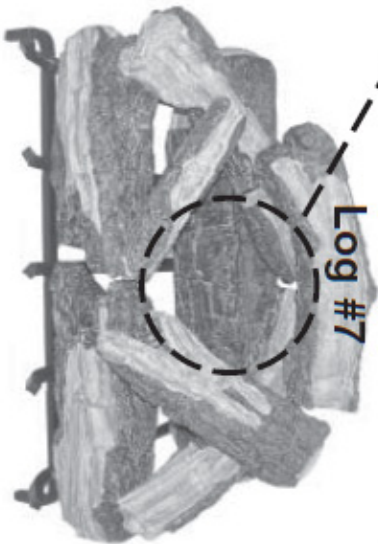

# INSTALLATION GUIDE

## Installing the Log Set

The damper clamp with hex bolt is provided as a means to prevent full closure of the damper blade. The clamp is easily attached to most, damper blades with pliers or a wrench, and must be permanently installed. The clamp is designed to prevent accidental closure of the damper when installed. Should the clamp not fit or fail to provide the permanent vent opening listed in the table above, have a permanent stop installed, remove the damper blade or have the damper cut to provide the minimum permanent opening required.

The Grand Canyon Gas Log set must be installed by a qualified professional service technician. Instructions must be followed carefully to ensure proper performance and full benefit from the gas log set. Check to be sure the log set is designed and labeled for the type of gas (natural or propane) supplied to the fireplace. Fireplace floor must be level clear of debris and smooth.

**WARNING:** Failure to position the parts in accordance with this manual or failure to use only parts specifically approved with this appliance may result in property loss, personal injury, or loss of life.

### BURNER INSTALLATION:

1. Make sure the fireplace gas supply is turned off
2. Locate the gas-supply stub inside the fireplace and remove the cap. When removing the cap make sure the stud does not turn, loosening the connection inside the wall.
3. Center the burner from side to side and position it as close to the back wall of the firebox. Ideally, the burner will be aligned directly under the flue damper.
4. Use the 3/8" aluminum flex line connector to connect the gas supply line to the gas inlet on the valve. When bending the aluminum flex line use proper bending procedures to avoid kinking the tubing.
5. Verify that connections are tight, then turn on the gas and check each connection using soap and water solution. **DO NOT USE AN OPEN FLAME FOR LEAK TESTING.** The soap and water connection should be 50% water and 50% soap. Brush the solution over the connections and check for bubbles. Any leak must be corrected prior to proceeding with installation.
6. Determine the valve system that is installed on the appliance, then proceed with lighting the pilot ( NOTE: Manual on/off valves do not have a pilot).
7. Before lighting the appliance make sure the heat shield is placed back in the position it was when the appliance was taken out of the box.

### BURNER MEDIA INSTALLATION:

1. Locate vermiculite (3 burner and LP units only) and the rock wool (Glowing Embers). Vermiculite is used for all propane units and for the ember burner on the 3 burner appliance.
  - a. Open the vermiculite, then evenly fill the entire ember pan area,
2. Open the bag of rock wool, then spread it evenly throughout the entire ember pan area. Tear the rock wool into smaller pieces and keeping it loosely packed will provide a better ember bed appearance.

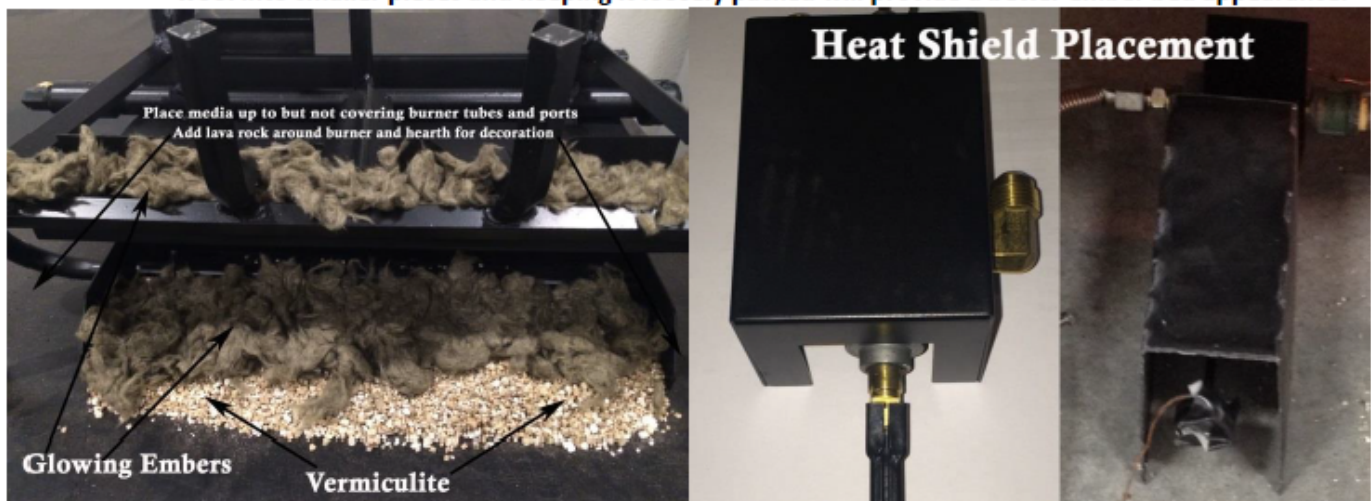

# INSTALLATION GUIDE

## OPERATING INSTRUCTIONS



### WARNING

Do NOT use this appliance if any part has been under water. Immediately call a qualified service technician to inspect the appliance and to replace any part of the control system and any gas control which has been under water.



### WARNING

Fire Risk / Burn Risk / HOT! DO NOT TOUCH

SEVERE BURNS MAY RESULT - CLOTHING IGNITION MAY RESULT

- Keep children away.
- CAREFULLY SUPERVISE children in the same area as the appliance.
- Alert children and adults to hazards of high temperatures.
- Clothing or other flammable materials should not be hung from the appliance or placed on or near the appliance.



### WARNING

This appliance should be inspected before use and at least annually by a qualified service person. More frequent cleaning may be required as necessary.

It is imperative that control compartment, burners and circulating air passageways of the appliance be kept clean.



### CAUTION

It is NOT recommended outdoor fire features be operated when wind exceeds 25 mph.

# INSTALLATION GUIDE

---

## LIGHTING INSTRUCTIONS

1. Prior to turning appliance on, visually inspect fire feature to ensure debris such as leaves or other combustible material has not collected inside the feature which could burn and emit embers once the fire feature is turned on. Also ensure any person standing close to the fire feature is aware that you will be turning the fire feature on prior to actually turning it on.
2. Turn the fire feature on by turning on the electrical device used to power the fire feature:
  - Sequence of Operation during Ignition:
    - Power is applied
    - Hot Surface Igniter (Glow Plug) becomes hot and Pilot Gas Valve opens
    - Within 10 seconds of power application Pilot Flame should be visible (at night only)
    - Within 10 seconds of Pilot Flame Ignition burner element (fire ring/burner bar) should ignite
3. Turn fire feature off by turning off the electrical device used to power the fire feature.

# INSTALLATION GUIDE

---

## TROUBLESHOOTING

**Q: I installed the Electronic Ignition System, turned it on and nothing happened.**

A: When this occurs it is usually due to an electrical wiring/power issue. Check all your electrical connections thoroughly to ensure all wires at the transformer and inside the fire feature are connected properly. If it appears all wiring is connected properly, disconnect the wires at the fire feature, attach a Multi-meter to the wires to confirm a minimum of 24 volts when the fire feature is turned on. If you determine that you do not have a minimum of 24 volts at the fire feature conduct the same test at the transformer to ensure the transformer is in fact producing a minimum of 24 volts. If you do have a minimum of 24 volts at the fire feature contact Acucraft for further assistance: 763-263-3156.

**Q: I installed the Electronic Ignition System, turned it on and I can see the glow plug glowing orange and I can hear gas flowing but it will not ignite.**

A: There are two possible causes to this problem: Air in the Gas Line or not enough Electrical Current to the fire feature.

**Air in the Gas Line.** If a new gas line was installed and the air was never purged from it prior to installing the Electronic Ignition System then it may take several times of turning the fire feature on and off before the air is purged from the gas line. Here is how our system works: after you turn it on the glow plug will come on first followed by the Pilot Gas Valve opening 4 seconds later. For the next 180 seconds (3 minutes) the glow plug will cycle on and off every 30 seconds while the Pilot Gas Valve will remain on the entire time. Therefore if you are attempting to purge air from the gas line, turn the system on and leave it on for approximately 3 minutes. Usually when purging air from a new gas line you will need to cycle the power several times as described above before gas begins to flow. If at any point you smell gas but still don't have ignition, attempt to light the Pilot flame with a handheld lighter. If the flame ignites when you light it by hand, go to the section below: "Electrical Current."

**Electrical Current.** If you have determined that air in the gas line is not the problem then most likely the failure to ignite is due to the fact that the glow plug is not getting hot enough to ignite the gas. The reason a glow plug will not get hot enough is due to the fact that it is not getting enough 'amps.' Often times when troubleshooting electricians will check the electrical power and when they see they have a minimum of 24 volts they think everything is fine electrically so there must be a problem with the Electronic Ignition System. The problem is not due to the volts but rather the amps. The number of amps reaching the fire feature is heavily dependent on the gauge wire used between the transformer and the fire feature. Our Install Instructions require no less than 12 gauge wire be run for all fire features. Often times we learn that in many cases less than 12 gauge wire has been used and herein lies the cause of the problem. *(Continued on next page)*

# INSTALLATION GUIDE

---

## TROUBLESHOOTING

1. CAUTION. Turn off the gas supply prior to the next step.
2. Using a clamp on the ammeter, clamp the ammeter around one of the wires providing power to the Electronic Ignition System.
3. Turn the fire feature on.
4. The amps you should see will range between 1.4 to 1.6 amps initially. Four seconds after being turned on the amps will jump to approximately 2.0 amps.

If you do not see the amps listed above AND the wire gauge used was less than 12 gauge wire - change the wiring. Otherwise contact Acucraft for further assistance: 763-263-3156.



# INSTALLATION GUIDE

---

## CAUTION

- Due to high temperatures, the appliance should be located out of traffic and away from furniture and draperies
- Children and adults should be alerted to the hazards of high surface temperatures and should stay away to avoid burns or clothing ignition
- Young children should be carefully supervised when they are in the same room as the appliance. Toddlers, young children and others may be susceptible to accidental contact burns. A physical barrier is recommended if there are at-risk individuals in the house. To restrict access to a fireplace or stove, install an adjustable safety gate to keep toddlers, young children and other at-risk individuals out of the room and away from hot surfaces
- Clothing or other flammable material should not be placed on or near the appliance
- Installation and repair should be done by a qualified service person. The appliance should be inspected before use and at least annually by a professional service person. More frequent cleaning may be required due to excessive lint from carpeting, bedding material, etc. It is imperative that control compartments, burners, and circulating air passageways of the appliance be kept clean
- Do not use this appliance if any part has been under water. Immediately call a qualified service technician to inspect the appliance and to replace any part of the control system and any gas control which has been under water
- This appliance is only intended for operation in temperatures above 32° F
- When shutting the unit down - be sure to TURN THE CONTROL VALVE FULLY OFF
- Every time you use the unit, make sure that:
  - The area around the unit is clear and free from combustible materials, gasoline and other flammable vapors and liquids
  - There is no blockage of the airflow through the vent openings
- **WARNING: HOT WHILE IN OPERATION AND FOLLOWING OPERATION. Serious injury can occur! DO NOT** throw trash, paper, or other flammable materials onto the unit. **DO NOT** leave in operation when unattended

# INSTALLATION GUIDE

---

## MAINTENANCE AND GENERAL CARE

- Examination and inspection of the appliance and all components including the burner, should be performed annually by a qualified service technician
- Examination and visual check of the burner & flame should be performed periodically to ensure proper operation
- Replacement of worn, broken, or non-functioning components should be left to a qualified service technician
- If glass panels suffer any type of impact, immediately cease use of fire pit until a qualified technician can assess the integrity of the panels and determine if they need replacement before continued use
- The area around the appliance must be kept clear and free from combustible materials, gasoline, and other flammable vapors and liquids
- The unit should be inspected regularly. Excessive debris can build up on this unit from leaves, dirt, or other debris. It is critical that all control components, burners, burner screen and vent opening be kept clean and free of all obstructions.



## WARNING

- Follow lighting instructions provided in this manual.
- Never use abrasive cleaners to clean the glass.
- Do not clean appliance when hot.
- Clean the tempered glass with a basic household glass cleaner. Never use glass cleaner that contains ammonia, as it may etch the tempered glass.



# PRODUCT SPECIFICATIONS

---

## SPECIFICATIONS

Height = 79 3/8"  
Width = 156"  
Depth = 36"  
Appx Weight. = 2,800 lbs.  
Gas Type = Natural Gas  
Electrical = Single 15 AMP service

**NATURAL GAS**  
Input Rating (BTU/hr) 0-1370 m = 290,000 BTUs/hr.  
Minimum inlet pressure (in.w.c.) = 7.0 in. W.C.  
Maximum inlet pressure (in.w.c.) = 10.5 in. W.C.

Based on testing that was performed, the following results have been recorded.  
Minimum Clearances to combustibles  
Unit to back wall of enclosure = 4 feet  
Unit to sidewall of enclosure = 4 feet  
Unit top to enclosure top = 8 feet

# PRODUCT SPECIFICATIONS

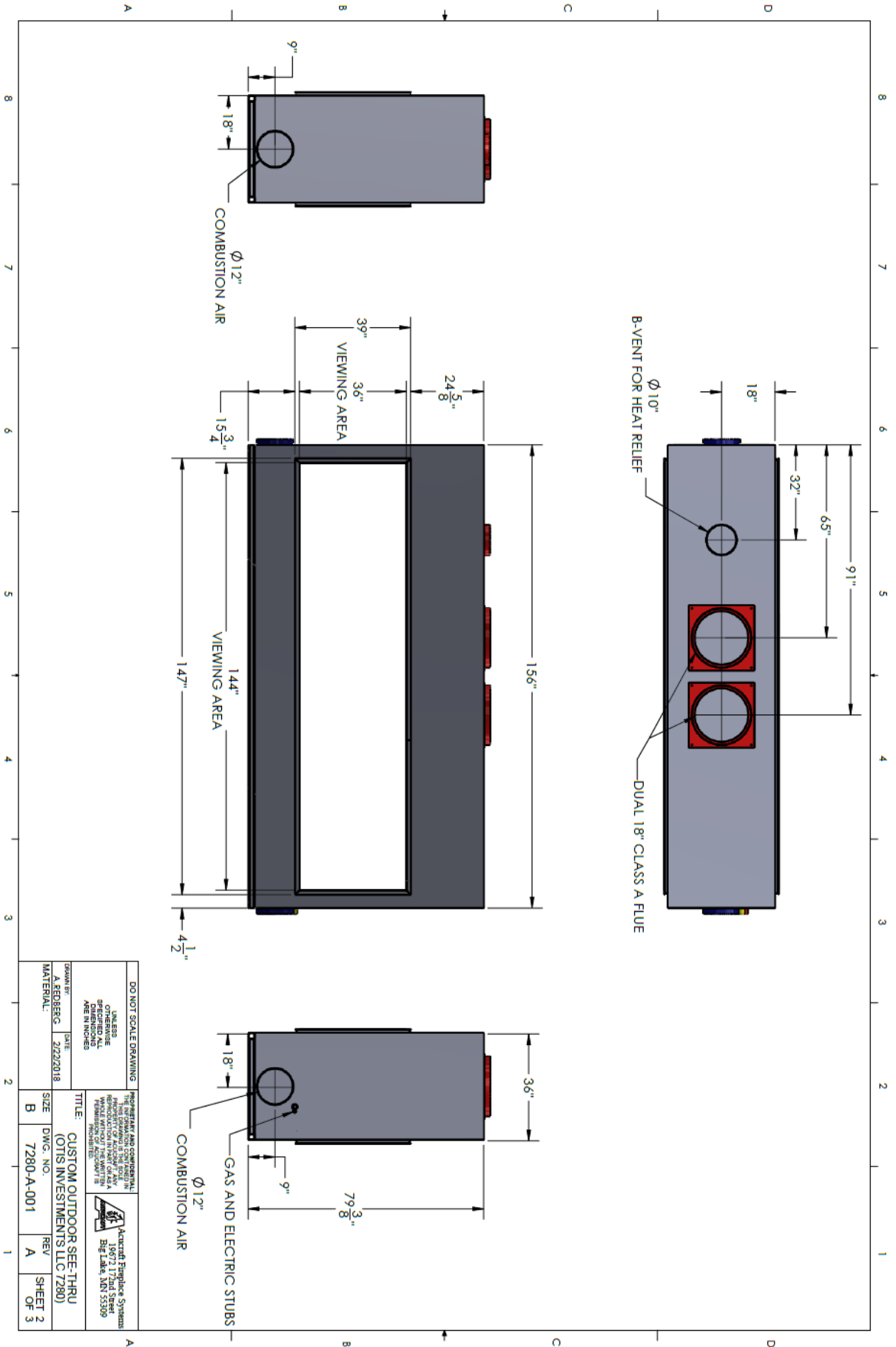

**DO NOT SCALE DRAWING**

<b>DRAWN BY:</b> A. REDBERG	<b>DATE:</b> 2/22/2018	<b>DESIGNER:</b> A. REDBERG	<b>CHECKED BY:</b> A. REDBERG
<b>MATERIAL:</b> STEEL	<b>FINISH:</b> PAINT	<b>INSTALLATION:</b> SEE NOTES	<b>MAINTENANCE:</b> SEE NOTES
<b>UNLESS OTHERWISE SPECIFIED, DIMENSIONS ARE IN INCHES.</b>		<b>PERMANENT AND COMPETING TRADE MARKS ARE THE PROPERTY OF THEIR RESPECTIVE OWNERS. ALL RIGHTS ARE RESERVED.</b>	
Accordia Fireplace Systems 4511 S. I-75 Big Lake, MN 55309		<b>TITLE:</b> CUSTOM OUTDOOR SEE THRU (OTIS INVESTMENTS LLC 7280)	
<b>SIZE:</b> B	<b>DWG. NO.:</b> 7280-A-001	<b>REV:</b> A	<b>SHEET</b> 2 <b>OF</b> 3

# PRODUCT SPECIFICATIONS

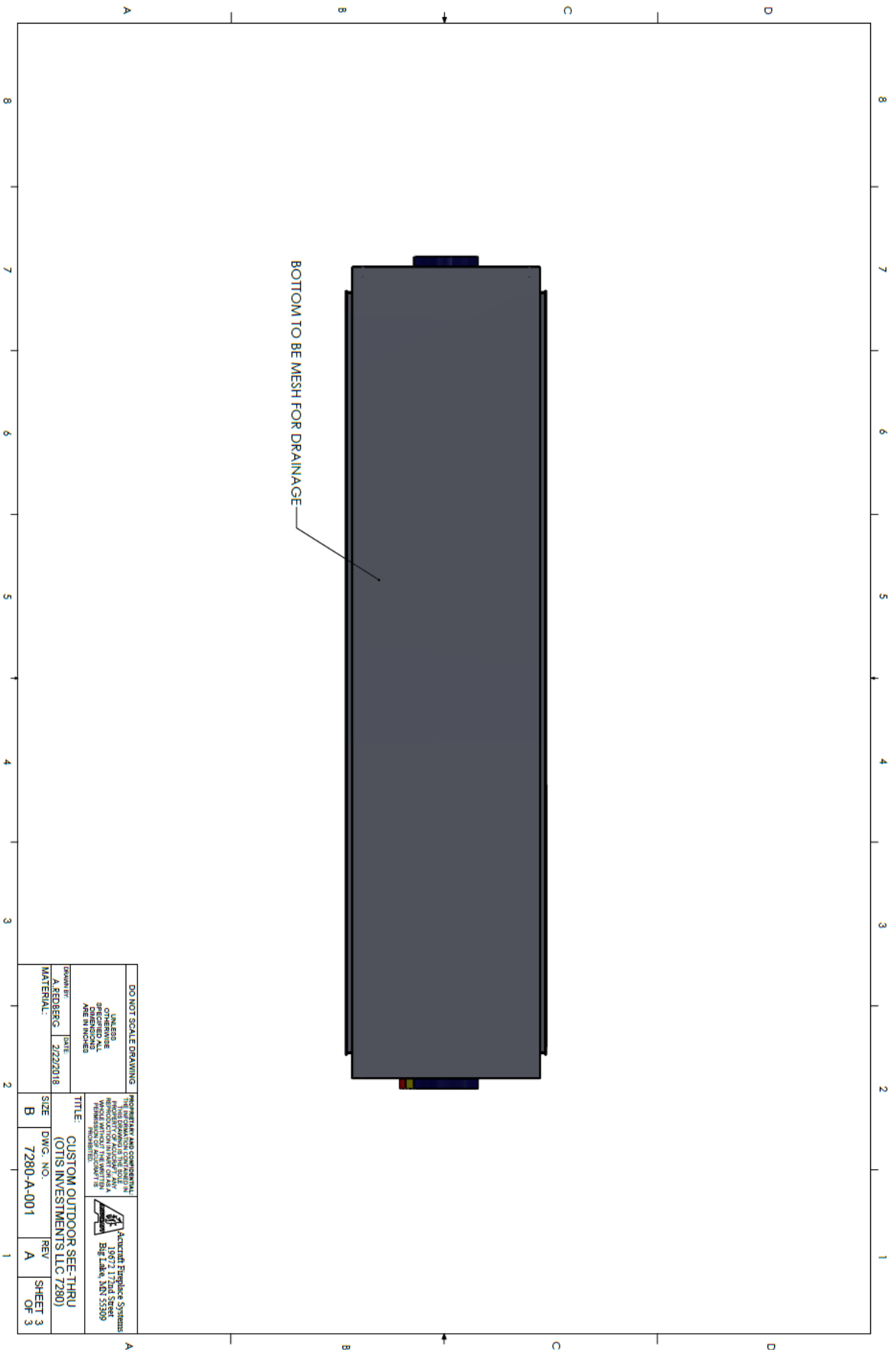



# PRODUCT SPECIFICATIONS

<b>MANUFACTURER: OUTDOOR DECORATIVE GAS APPLIANCE</b>	
Acucraft Fireplaces MODEL/ MODELE: Outdoor 13' See Through Fireplace	
19672 172nd St Big Lake, MN 55309 (763) 263-3156	
<b>GAS / TYPE DE GAZ:</b>	Natural Gas (Gaz naturel)
INPUT RATING (ENTRÉE NOTE) (Btu/hr) 0-610m:	290,000
ORIFICE SIZE (DIMENSIONS DE L'ORIFICE) (DMS) 0-610m:	3/4
INPUT RATING (ENTRÉE NOTE) (Btu/hr) 610-1370m:	280,000
ORIFICE SIZE (DIMENSIONS DE L'ORIFICE) (DMS) 610-1370m:	3/4
MANIFOLD PRESSURE (PRESSION D'ADMISSION) (in. wc/kPa):	3.5" wc
MINIMUM INLET PRESSURE (MINIMUM PRESSION D'ENTRÉE) (in. wc/kPa):	7.0" wc

**For Outdoor Use Only. If Stored Indoors, Detach and Leave Cylinder Outdoors.**  
**Pour utilisation à l'extérieur seulement. Si l'appareil est entreposé à l'intérieur enlever les bouteilles et les laisse à l'extérieur.**

Follow installation instruction. Suivez les instructions d'installation.	<b>Minimum clearances to combustibles:</b> Unit to back wall of enclosure: 4 feet Unit to sidewall of enclosure: 4 feet Unit top to enclosure cap: 8 feet
---	--

CERTIFIED FOR CANADA/ CERTIFIÉ POUR LE CANADA ANSI Z21.97-2014, CSA 2.41-2014, Outdoor Decorative Gas Appliances.		Lab Test 	
<b>DO NOT REMOVE THIS LABEL</b> <b>N'ENLEVEZ PAS CETTE ETIQUETTE</b>			
 <b>DANGER</b>	<b>CARBON MONOXIDE HAZARD</b> This appliance can produce carbon monoxide which has no odor.  Using it in an enclosed space can kill you.  Never use this appliance in an enclosed space such as a camper, tent, car or home.	 <b>DANGER</b>	<b>MONOXYDE DE CARBONE</b> Cette appareil peut produire du monoxyde de carbone, un gaz inodore. L'utilisation de cet appareil dans des espaces clos peut entraîner la mort.  Ne jamais utiliser cet appareil dans un espace clos comme un véhicule de camping, une tente, une automobile ou une maison.
			

# NOTES



A series of horizontal lines for writing notes, consisting of 30 evenly spaced lines.

# ***WARRANTY***

---



## **FIRE IS OUR PASSION**

---

*www.acucraft.com*      888-317-6499

Acucraft Fireplaces  
19672 172nd Street  
Big Lake, MN 55309